

| | | | |
|-------------|---|---------------------------------|--|
| Montageart | Einbau-, Aufbau- und Pendelleuchte | Leistung/m | LO: 21W/m 1050mA HO: 29W/m 1400mA |
| Oberfläche | Aluminium natur eloxiert, schwarz oder weiß pulverbeschichtet RAL oder NCS Farbtöne auf Anfrage | Leistung/m Wallwasher linear | LO: 20W/m 700mA HO: 26W/m 900mA |
| Cover | Satiniert Diamant Prismen U-Form Wallwasher linear | Abmessungen | H: 32,5 mm B: 48 mm L: auf Kundenwunsch max. Profillänge 6000mm |
| LED Platine | Lichtfarben 2700 K 3000 K 4000 K oder tuneable white 2700 5700 K Lichtfarbe nach Wahl Bestückungsvarianten auf Anfrage | Montageart „Einbau“ | ET: min. 65 mm DA: Breite 50 mm x Länge + 2 mm (randlos) |
| | | Schutzart | IP20 |

LED Lichtstrom pro Laufmeter

| Cover | Low Output (LO) | High Output (HO) |
|--------------------------------------|---|---|
| Satiniert Diamant Prismen U-Form | 2830 lm/m 2700K CRI 90 3150 lm/m 3000K CRI 90 3310 lm/m 4000K CRI 90 tuneable white 2700K 5700K 2830 lm /m bei 2700K CRI 90 | 3700 lm/m 2700K CRI 90 4110 lm/m 3000K CRI 90 4320 lm/m 4000K CRI 90 tuneable white 2700K 5700K 3700 lm /m bei 2700K CRI 90 |
| Wallwasher linear | 2520 lm/m 2700K CRI 90 2640 lm/m 3000K CRI 90 2760 lm/m 4000K CRI 90 tuneable white 2700K 5700K 2520 lm /m bei 2700K CRI 90 | 3200 lm/m 2700K CRI 90 3350 lm/m 3000K CRI 90 3500 lm/m 4000K CRI 90 tuneable white 2700K 5700K 3200 lm /m bei 2700K CRI 90 |

Driver Optionen siehe Seite 5



DATENBLATT – BASE 32 - LINEAR BESPOKE KONFIGURATIONSMÖGLICHKEITEN



MONTAGEARTEN

Einbauleuchten

Aufbauleuchten

Pendelleuchten

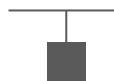

Breite 50 mm x Länge + 2 mm, randlos

SATINIERT | DIAMANT PRISMEN | U-FORM - AUSWAHL ZUR KONFIGURATION

560



Mono LO 3000K : 1765 lm | 12 W
Mono HO 3000K : 2300 lm | 16 W

TW LO 2700K : 1585 lm | 12 W
TW HO 2700K : 2070 lm | 16 W

280

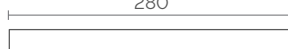

Mono LO 3000K : 880 lm | 6 W
Mono HO 3000K : 1150 lm | 8 W

TW LO 2700K : 795 lm | 6 W
TW HO 2700K : 1035 lm | 8 W

140

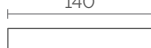

Mono LO : 440 lm | 3 W
Mono HO: 575 lm | 4 W

TW LO 2700K: 400 lm | 3 W
TW HO 2700K: 520 lm | 4 W

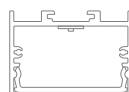

Nennstrom:
LO 1050mA | HO 1400mA

WALLWASHER LINEAR - AUSWAHL ZUR KONFIGURATION

525

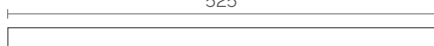

Mono LO 3000K : 1.390 lm | 10,5 W
Mono HO 3000K : 1.760 lm | 14 W

TW LO 2700K: 1.320 lm | 10,5 W
TW HO 2700K: 1.680 lm | 14 W

210

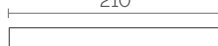

Mono LO 3000K : 695 lm | 5,5 W
Mono HO 3000K : 880 lm | 7 W

TW LO: 660 lm bei 2700K | 5,5 W
TW HO: 840 lm bei 2700K | 7 W

105

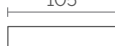

Mono LO 3000K : 350 lm | 2,75 W
Mono HO 3000K : 440 lm | 3,5 W

TW LO 2700K: 330 lm bei 2700K | 2,75 W
TW HO 2700K: 420 lm bei 2700K | 3,5 W

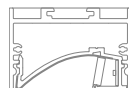

Nennstrom:
LO 700mA | HO 900mA

INDIREKT - AUSWAHL ZUR KONFIGURATION

1760 lm / 11 W



indirekt

880 lm / 5 W



indirekt

440 lm / 4 W



indirekt

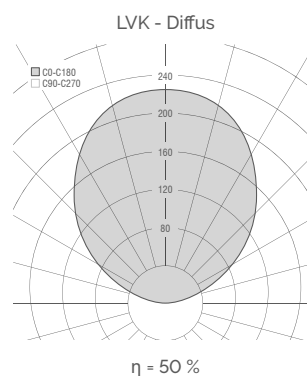

LINEAR - PROFILANWENDUNG



| Reflektoren | BASE 32 | BASE 33 | BASE 42 | BASE 52 | BASE 65 | BASE 66 | BASE 70 | BASE 85 |
|-------------------|---------|---------|---------|---------|---------|---------|---------|---------|
| Satiniert | ✓ | ✓ | ✓ | ✓ | ✓ | ✓ | ✓ | ✓ |
| Diamant Prismen | ✓ | ✓ | ✗ | ✓ | ✓ | ✓ | ✓ | ✓ |
| U-Form Typ 1 | ✓ | ✓ | ✗ | ✗ | ✓ | ✓ | ✗ | ✓ |
| U-Form Typ 2 | ✓ | ✗ | ✗ | ✗ | ✓ | ✗ | ✗ | ✓ |
| Wallwasher linear | ✓ | ✓ | ✗ | ✓ | ✓ | ✓ | ✓ | ✓ |
| indirekt | ✓ | ✗ | ✓ | ✓ | ✗ | ✗ | ✓ | ✗ |

SATINIERT | DIAMANT PRISMEN | U-FORM - LÄNGE PROFIL

PCB Länge min. 840mm - max. 2240mm / Driver

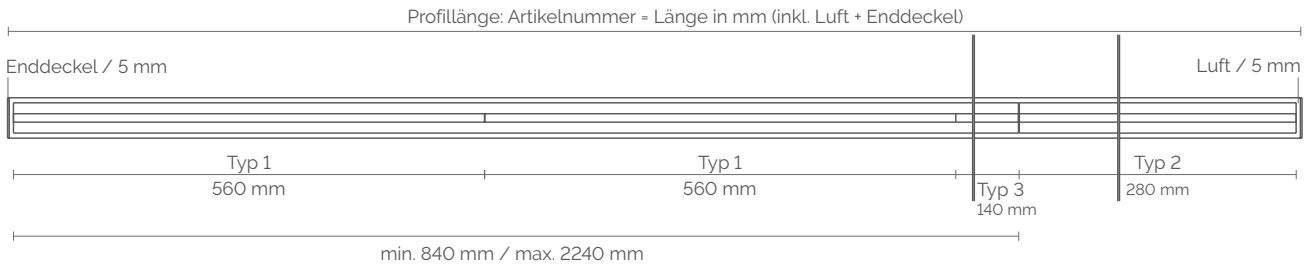

WALLWASHER LINEAR - LÄNGE PROFIL

PCB Länge min. 840mm - max. 1575mm / Driver

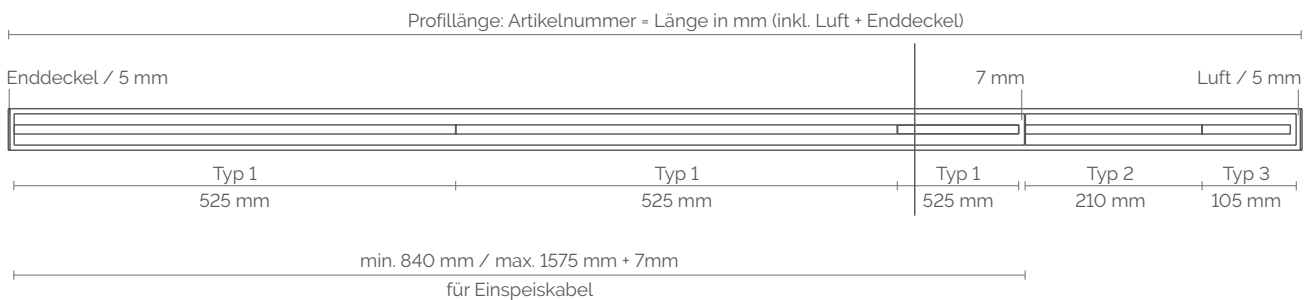

COVER

Satiniert
Diamant Prismen klar
Diamant Prismen mit Satinato Folie
U-Form Typ 1 Diffusor
U-Form Typ 2 Diffusor
Wallwasher linear

PROFIL OBERFLÄCHE

A6 / Co aluminium eloxiert
RAL 9016 FS verkehrsweiss
RAL 9005 FS tiefschwarz
weitere RAL oder NCS Farbtöne auf Anfrage

ENERGIEVERSORGUNG DRIVER

| | |
|---------------|------------------------------|
| Deckeneinwurf | non dimmable |
| Profileinbau | non dimmable |
| Deckeneinwurf | DALI dimmable DT 6 |
| Deckeneinwurf | DALI dimmable DT 8 (TW only) |
| Profileinbau* | DALI dimmable DT 6 |
| Profileinbau* | DALI dimmable DT 8 (TW only) |

*Driver Profileinbau hinter Blindteil:
Platzbedarf L=550mm

Deckeneinwurf: bei der Installation der Leuchte darf der LED Driver primärseitig nicht unter Spannung stehen!
Die LED kann dadurch nachhaltig beschädigt werden.

**DATENBLATT – BASE 32 - LINEAR
BESPOKE**
KONFIGURATIONSMÖGLICHKEITEN



LED PLATINE - TECHNISCHE DATEN



| | W | CTT in K | φ LED lm | η Satinert | φ Nutz lm | η Diamant Prisma | φ Nutz lm | η Diamant Prisma Folie | φ Nutz lm | η U-Form Typ 1 | φ Nutz lm | η U-Form Typ 2 | φ Nutz lm |
|-------------|----|-----------------|-------------|---------------|--------------|------------------------|--------------|------------------------------|--------------|----------------------|--------------|----------------------|--------------|
| LOW OUTPUT | 12 | 2700 | 1585 | 68% | 1078 | 70% | 1110 | 60% | 951 | 50% | 793 | 50% | 793 |
| | 12 | 3000 | 1765 | 68% | 1200 | 70% | 1236 | 60% | 1059 | 50% | 883 | 50% | 883 |
| | 12 | 4000 | 1855 | 68% | 1261 | 70% | 1299 | 60% | 1113 | 50% | 928 | 50% | 928 |
| | 12 | TW 2700/5700 | 1585/2040 | 68% | 1078/1387 | 70% | 1110/1428 | 60% | 951/1224 | 50% | 793/1020 | 50% | 793/1020 |
| HIGH OUTPUT | 18 | 2700 | 2070 | 68% | 1408 | 70% | 1449 | 60% | 1242 | 50% | 1035 | 50% | 1035 |
| | 18 | 3000 | 2300 | 68% | 1564 | 70% | 1610 | 60% | 1380 | 50% | 1150 | 50% | 1150 |
| | 18 | 4000 | 2420 | 68% | 1646 | 70% | 1694 | 60% | 1452 | 50% | 1210 | 50% | 1210 |
| | 18 | TW 2700/5700 | 2070/2660 | 68% | 1408/1809 | 70% | 1449/1862 | 60% | 1242/1596 | 50% | 1035/1330 | 50% | 1035/1330 |



| | W | CTT in K | φ LED lm | η Wallwasher linear | φ Nutz lm |
|-------------|----|--------------|-------------|------------------------|--------------|
| LOW OUTPUT | 11 | 2700 | 1320 | 60% | 792 |
| | 11 | 3000 | 1390 | 60% | 834 |
| | 11 | 4000 | 1450 | 60% | 870 |
| | 11 | TW 2700/5700 | 1320/1590 | 60% | 792/954 |
| HIGH OUTPUT | 14 | 2700 | 1680 | 60% | 1008 |
| | 14 | 3000 | 1760 | 60% | 1056 |
| | 14 | 4000 | 1840 | 60% | 1104 |
| | 14 | TW 2700/5700 | 1680/2020 | 60% | 1008/1212 |

LED Lichtstrom und Leistung je nach verfügbarer Selektion +/- 10%
Toleranz Lichtfarbe +/- 150K

**DATENBLATT – BASE 32 - LINEAR
BESPOKE
COVER ZUR KONFIGURATION**

LED PLATINE - TECHNISCHE DATEN



| | W | CTT in K | φ LED lm | η Satiniert | φ Nutz lm | η Diamant Prisma | φ Nutz lm | η Diamant Prisma Folie | φ Nutz lm | η U-Form Typ 1 | φ Nutz lm | η U-Form Typ 2 | φ Nutz lm |
|-------------|---|-----------------|-------------|----------------|--------------|------------------------|--------------|------------------------------|--------------|----------------------|--------------|----------------------|--------------|
| LOW OUTPUT | 6 | 2700 | 795 | 68% | 541 | 70% | 557 | 60% | 477 | 50% | 398 | 50% | 398 |
| | 6 | 3000 | 885 | 68% | 602 | 70% | 620 | 60% | 531 | 50% | 443 | 50% | 443 |
| | 6 | 4000 | 930 | 68% | 632 | 70% | 651 | 60% | 558 | 50% | 465 | 50% | 465 |
| | 6 | TW 2700/5700 | 795/1020 | 68% | 541/694 | 70% | 557/714 | 60% | 477/612 | 50% | 398/510 | 50% | 398/510 |
| HIGH OUTPUT | 9 | 2700 | 1035 | 68% | 704 | 70% | 725 | 60% | 621 | 50% | 518 | 50% | 518 |
| | 9 | 3000 | 1150 | 68% | 782 | 70% | 805 | 60% | 690 | 50% | 575 | 50% | 575 |
| | 9 | 4000 | 1210 | 68% | 823 | 70% | 847 | 60% | 726 | 50% | 605 | 50% | 605 |
| | 9 | TW 2700/5700 | 1035/1330 | 68% | 704/904 | 70% | 725/931 | 60% | 621/798 | 50% | 518/665 | 50% | 518/665 |



| | W | CTT in K | φ LED lm | η Wallwasher linear | φ Nutz lm |
|-------------|---|--------------|-------------|------------------------|--------------|
| LOW OUTPUT | 6 | 2700 | 660 | 60% | 396 |
| | 6 | 3000 | 695 | 60% | 417 |
| | 6 | 4000 | 725 | 60% | 435 |
| | 6 | TW 2700/5700 | 660/800 | 60% | 396/480 |
| HIGH OUTPUT | 7 | 2700 | 840 | 60% | 504 |
| | 7 | 3000 | 880 | 60% | 528 |
| | 7 | 4000 | 920 | 60% | 552 |
| | 7 | TW 2700/5700 | 840/920 | 60% | 504/552 |

LED Lichtstrom und Leistung je nach verfügbarer Selektion +/- 10%
Toleranz Lichtfarbe +/- 150K

**DATENBLATT – BASE 32 - LINEAR
BESPOKE
COVER ZUR KONFIGURATION**



LED PLATINE - TECHNISCHE DATEN



| | W | CTT in K | φ LED lm | η Satinert | φ Nutz lm | η Diamant Prisma | φ Nutz lm | η Diamant Prisma Folie | φ Nutz lm | η U-Form Typ 1 | φ Nutz lm | η U-Form Typ 2 | φ Nutz lm |
|-------------|---|-----------------|-------------|---------------|--------------|------------------------|--------------|------------------------------|--------------|----------------------|--------------|----------------------|--------------|
| LOW OUTPUT | 3 | 2700 | 400 | 68% | 272 | 70% | 280 | 60% | 240 | 50% | 200 | 50% | 200 |
| | 3 | 3000 | 440 | 68% | 299 | 70% | 308 | 60% | 264 | 50% | 220 | 50% | 220 |
| | 3 | 4000 | 465 | 68% | 316 | 70% | 326 | 60% | 279 | 50% | 233 | 50% | 233 |
| | 3 | TW 2700/5700 | 400/510 | 68% | 272/347 | 70% | 280/357 | 60% | 240/306 | 50% | 200/255 | 50% | 200/255 |
| HIGH OUTPUT | 5 | 2700 | 520 | 68% | 354 | 70% | 364 | 60% | 312 | 50% | 260 | 50% | 260 |
| | 5 | 3000 | 575 | 68% | 391 | 70% | 403 | 60% | 345 | 50% | 288 | 50% | 288 |
| | 5 | 4000 | 605 | 68% | 411 | 70% | 424 | 60% | 363 | 50% | 303 | 50% | 303 |
| | 5 | TW 2700/5700 | 520/665 | 68% | 354/452 | 70% | 364/466 | 60% | 312/399 | 50% | 260/333 | 50% | 260/333 |



| | W | CTT in K | φ LED lm | η Wallwasher linear | φ Nutz lm |
|-------------|---|--------------|-------------|------------------------|--------------|
| LOW OUTPUT | 3 | 2700 | 330 | 60% | 198 |
| | 3 | 3000 | 350 | 60% | 210 |
| | 3 | 4000 | 365 | 60% | 219 |
| | 3 | TW 2700/5700 | 330/400 | 60% | 198/240 |
| HIGH OUTPUT | 4 | 2700 | 420 | 60% | 252 |
| | 4 | 3000 | 440 | 60% | 264 |
| | 4 | 4000 | 460 | 60% | 276 |
| | 4 | TW 2700/5700 | 420/510 | 60% | 252/306 |

LED Lichtstrom und Leistung je nach verfügbarer Selektion +/- 10%
Toleranz Lichtfarbe +/- 150K

DATENBLATT – BASE 32 - LINEAR
BESPOKE - INDIREKT
ZUBEHÖR



| CTT in K | W/m | LOW OUTPUT | | | HIGH OUTPUT | | | |
|--------------|-----|--------------|-----|--------------|-------------|----------|-----|-------------|
| | | φ LED lm | η | φ Nutz lm | W | φ LED lm | η | φ Nutz lm |
| 2700 | 21 | 2830 | 50% | 1415 | xxx | xxx | 50% | xxx |
| 3000 | 21 | 3150 | 50% | 1575 | xxxx | xxx | 50% | xxx |
| 4000 | 21 | 3310 | 50% | 1655 | xxx | xxx | 50% | xxx |
| TW 2700/5700 | 21 | 2830 (2700K) | 50% | 1415 (2700K) | xxx (2700K) | xxx | 50% | xxx (2700K) |

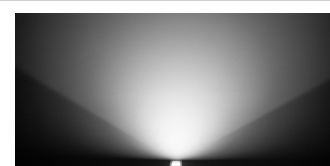

ZUBEHÖR

Zubehör je nach Montageart separat bestellen:

| Produkte | Montagearten | grau | weiss | schwarz |
|---|--------------|----------|-------|---------|
| Enddeckel | | 325004 | -5 | -6 |
| Befestigungsbohrung - Montagelöcher im Profil vorgebohrt; Ø 4,5mm | | - | - | - |
| Einbaumontagebügel für GK-Decken 12,5mm | | 325008 | - | - |
| Einspeiskabel L=2.000mm mit quadratischem Baldachin 3-polig | | 325012-3 | -5 | -6 |
| Einspeiskabel L=2.000mm mit quadratischem Baldachin 5-polig | | 325012-5 | -5 | -6 |
| Seilabhängung L=2.000mm, stufenlos höhenverstellbar | | 325014 | - | - |
| Gipskarton Einbaukanal zur randlosen Montage in abgehängte Decken | | 325020 | - | - |

ZUBEHÖR - GIPSKARTON EINBAUKANAL

Gipsformteil zum bündigen Einbau in Gipskarton

L= 2.000 mm
 BASE 32 und 65

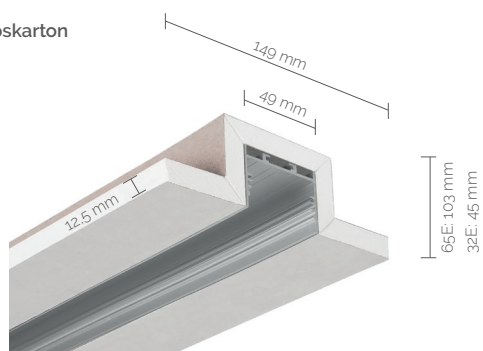

LED Lichtstrom und Leistung je nach verfügbarer Selektion +/- 10%
 Toleranz Lichtfarbe +/- 150K

DATENBLATT – BASE 32 - LINEAR
ANSCHLUSSFERTIGE LEUCHTE
DIFFUS - PRISMEN - U-FORM

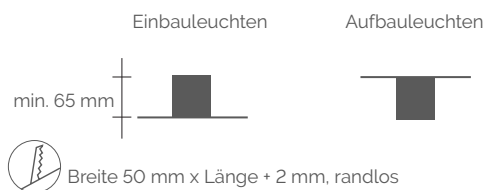

| K | L=mm | Low Output | | High Output | | code | code |
|--------|-------|------------|-------|-------------|--------|-----------|-----------|
| | | W | lm | W | lm | | |
| 3000 K | 1.150 | 24 | 3.530 | 33 | 4.600 | 3032E01XY | 3032A01XY |
| CRI 90 | 1.570 | 33 | 4.850 | 45 | 6.330 | 3032E03XY | 3032A03XY |
| | 2.130 | 45 | 6.615 | 61 | 8.630 | 3032E05XY | 3032A05XY |
| | 2.970 | 62 | 9.260 | 85 | 12.085 | 3032E07XY | 3032A07XY |

TECHNISCHE DATEN PER METER

| | W/m | lm/m | W/m | lm/m |
|-------------------------|-----|---------------|-----|---------------|
| 2700 K CRI 90 | 21 | 2.830 | 29 | 3.700 |
| 3000 K CRI 90 | 21 | 3.150 | 29 | 4.110 |
| 4000 K CRI 90 | 21 | 3.310 | 29 | 4.320 |
| TW 2700 / 5700 K CRI 90 | 21 | 2.830 (2700K) | 29 | 3.700 (2700K) |

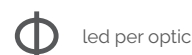

Y_ LICHTFARBE / CCT

| |
|------------------------------|
| 2700 K LO |
| 3000 K LO |
| 4000 K LO |
| 2700 K HO |
| 3000 K HO |
| 4000 K HO |
| tuneable white - auf Anfrage |

code

| |
|---|
| 2 |
| 3 |
| 4 |
| 5 |
| 6 |
| 7 |

Y_ COVER

| |
|---------------------------------|
| Satiniert |
| Diamant Prismen klar |
| Diamant Prismen Satinato Folie |
| U-Form Diffusor Typ 1 |
| U-Form Diffusor Typ 2 |
| Wallwasher linear - auf Anfrage |

code

| |
|---|
| 1 |
| 2 |
| 3 |
| 4 |
| 6 |

η

| |
|-----|
| 68% |
| 70% |
| 60% |
| 50% |
| 50% |
| 60% |

+ _ OBERFLÄCHE

| |
|-------------|
| A6 / CO |
| RAL 9016 FS |
| RAL 9005 FS |

code

| |
|---|
| 4 |
| 5 |
| 6 |

+ _ ENERGIEVERSORGUNG

| |
|---------------------------------|
| nicht dimmbar |
| D DALI dimmable DT 6 |
| D8 DALI dimmable DT 8 (TW only) |

RAL oder NCS Farbtöne - auf Anfrage

tuneable white nur DALI dimmbar lieferbar

ZUBEHÖR

Zubehör je nach Montageart inkludiert
Enddeckel, Befestigungsbohrung, Einbaumontagebügel für GK-Decken 12,5mm,
sekundärseitige Anschlussleitung mit Stecker
Entsprechender LED Konverter als Deckeneinwurfgerät
Optionales Zubehör: Gipskarton Einbaukanal zur randlosen Montage in abgehängte Decken

LED Lichtstrom und Leistung je nach verfügbarer Selektion +/- 10% Toleranz Lichtfarbe +/- 150K

$$\Phi_{\text{nutz}} = \Phi_{\text{led}} \times \eta$$

DATENBLATT – BASE 32 - LINEAR
ANSCHLUSSFERTIGE LEUCHTE
DIFFUS - PRISMEN - U-FORM



Pendelleuchten

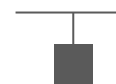

Pendelleuchten+

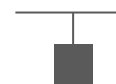

D/I

| K | L=mm | Low Output | | indirect LO | | High Output | | code | code |
|--------|-------|------------|-------|-------------|-------|-------------|--------|-----------|-----------|
| | | W | lm | W | lm | W | lm | | |
| 3000 K | 1150 | 24 | 3.530 | 16 | 2.650 | 33 | 4.600 | 3032P01XY | 3032P02XY |
| CRI 90 | 1.570 | 33 | 4.850 | 24 | 3.350 | 45 | 6.330 | 3032P03XY | 3032P04XY |
| | 2.130 | 45 | 6.615 | 32 | 5.290 | 61 | 8.630 | 3032P05XY | 3032P06XY |
| | 2.970 | 62 | 9.260 | 43 | 7.060 | 85 | 12.085 | 3032P07XY | 3032P08XY |

TECHNISCHE DATEN PER METER

| | W/m | lm/m | W/m | lm/m | |
|-------------------------|-----|---------------|-----|---------------|---------------|
| 2700 K CRI 90 | 21 | 2.830 | 29 | 3.700 | led per optic |
| 3000 K CRI 90 | 21 | 3.150 | 29 | 4.110 | |
| 4000 K CRI 90 | 21 | 3.310 | 29 | 4.320 | |
| TW 2700 / 5700 K CRI 90 | 21 | 2.830 (2700K) | 29 | 3.700 (2700K) | |
| | | | | | |

Y_ LICHTFARBE / CCT

| |
|-----------------------------|
| 2700 K LO |
| 3000 K LO |
| 4000 K LO |
| 2700 K HO |
| 3000 K HO |
| 4000 K HO |
| tunable white - auf Anfrage |

code

| |
|---|
| 2 |
| 3 |
| 4 |
| 5 |
| 6 |
| 7 |

Y_ COVER

| |
|---------------------------------|
| Satiniert |
| Diamant Prismen klar |
| Diamant Prismen Satinato Folie |
| U-Form Diffusor Typ 1 |
| U-Form Diffusor Typ 2 |
| Wallwasher linear - auf Anfrage |

code

| |
|---|
| 1 |
| 2 |
| 3 |
| 4 |
| 6 |

η

| |
|-----|
| 68% |
| 70% |
| 60% |
| 50% |
| 50% |
| 60% |

+ _ OBERFLÄCHE

| |
|-------------|
| A6 / CO |
| RAL 9016 FS |
| RAL 9005 FS |

RAL oder NCS Farbtöne - auf Anfrage

code

| |
|---|
| 4 |
| 5 |
| 6 |

+ _ ENERGIEVERSORGUNG

| |
|---------------------------------|
| nicht dimmbar |
| D DALI dimmable DT 6 |
| D8 DALI dimmable DT 8 (TW only) |

tunable white nur DALI dimmbar lieferbar

ZUBEHÖR

Zubehör inkludiert
Enddeckel, Einspeisekabel mit quadratischem Baldachin, Seilabhängung L=2.000mm,
frei verschiebbar und stufenlos höhenverstellbar
Entsprechender LED Konverter als Deckeneinwurfgerät

LED Lichtstrom und Leistung je nach verfügbarer Selektion +/- 10% Toleranz Lichtfarbe +/- 150K

$$\Phi_{\text{nutz}} = \Phi_{\text{led}} \times \eta$$

DATENBLATT – BASE 32

ANSCHLUSSBELEGUNG (DRIVER INTEGRIERT)



3 POLIG - NICHT DIMMBAR

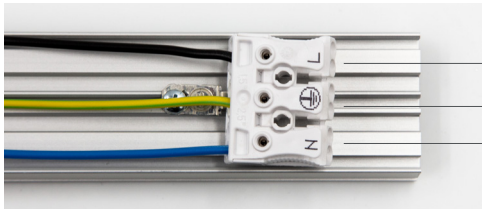

LEUCHTENSEITE

- L - SCHWARZ - PHASE
- ⊕ - GELB/GRÜN - SCHUTZERDUNG
- N - BLAU - NEUTRALLEITER

BAUSEITIGER ANSCHLUSS

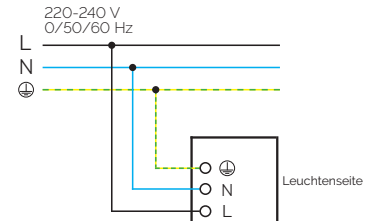

5 POLIG - DALI DIMMBAR



LEUCHTENSEITE

- DA- - ORANGE - DALI 2
- DA+ - VIOLETT - DALI 1
- ⊕ - GELB/GRÜN - SCHUTZERDUNG
- N - BLAU - NEUTRALLEITER
- L - SCHWARZ - PHASE

BAUSEITIGER ANSCHLUSS

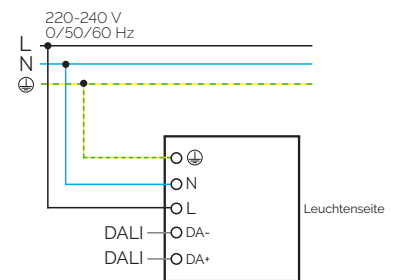

5 POLIG - PUSH DIMMBAR

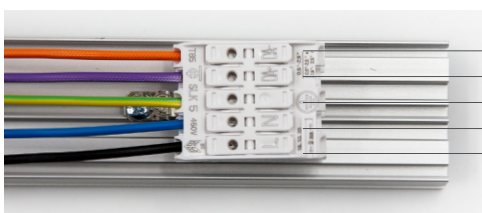

LEUCHTENSEITE

- DA- - ORANGE - TASTER
- DA+ - VIOLETT - NEUTRALLEITER (gebrückt)
- ⊕ - GELB/GRÜN - SCHUTZERDUNG
- N - BLAU - NEUTRALLEITER
- L - SCHWARZ - PHASE

BAUSEITIGER ANSCHLUSS

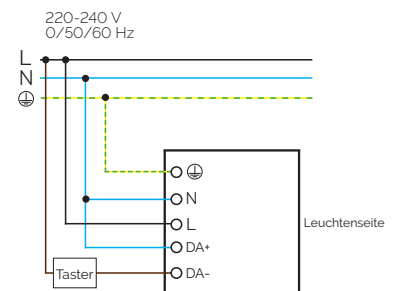

DATENBLATT – BASE 32
ANSCHLUSSBELEGUNG BALDACHIN
FÜR PENDELLEUCHTE



L: 80 mm
 B: 80 mm
 H: 35 mm



L=4.000mm auf Anfrage

3 POLIG - NICHT DIMMBAR

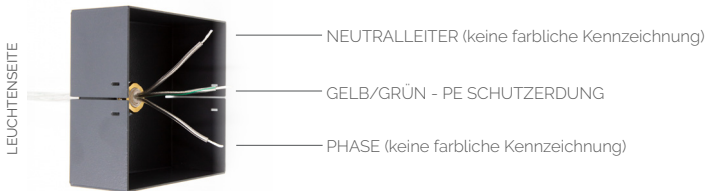

NETZSEITIGER ANSCHLUSS

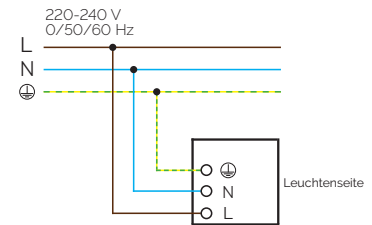

5 POLIG - DALI DIMMBAR

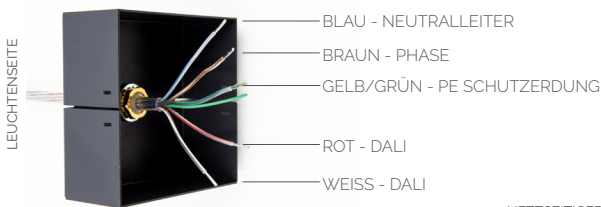

NETZSEITIGER ANSCHLUSS

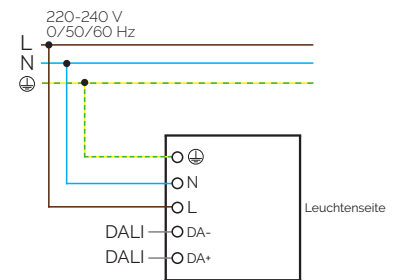

5 POLIG - PUSH DIMMBAR

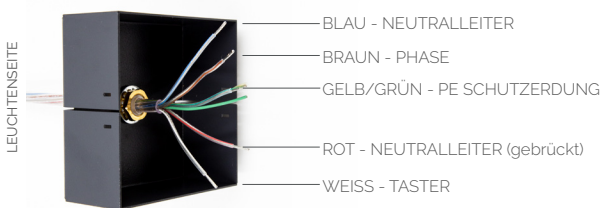

NETZSEITIGER ANSCHLUSS

